



Commando DC130Ri T3 SURFACE DRILLS

TECHNICAL SPECIFICATION

Commando DC130Ri is a fully remote controlled, hydraulic and self-propelled drilling unit on a 4-wheel drive carrier.

Typical applications for Commando DC130Ri are foundation drilling, road cutting, trenching, bolting, line drilling in dimensional stone quarries, and other special drilling applications. Therefore Commando DC130Ri is most often used by construction contractors, mines and quarries and the municipal sector. Due to its versatility Commando DC130Ri is often included in the equipment fleet of rental houses as well.

KEY FEATURES

Hole diameter:	22 - 45 mm (7/8" - 1 3/4")
Rock tools:	H19, H22, H25, R23, R25, R28
Rock Drill	5,5 kW
Engine output:	36,3 kW
Flushing air:	1,2 m3/min, up to 8 bar
Production capacity:	300 - 540 m3/8h
Total weight :	3250 kg



HYDRAULIC ROCK DRILL

Rock drill	RD106
Rock tools	H19 x 108 mm, H22 x 108 mm, H25 x 108 mm, R23, R25, R28
Operating pressure	100 - 160 bar
Percussion output power	5,5 kW
Maximum rotation torque	100 Nm/140 bar
Shank lubrication	Air / oil mist
Flushing	Air / Water
Weight	52 kg

FEED

Feed type	CF 100 x 32 / RD106
Total length	4 540 mm
Rock drill travel	2900 mm
Max. length of starter rod	3 700 mm
Feed extension travel	600 mm (2')
Feed/pull out force	3.7 kN
Feed swing	+/- 47°
Feed tilt	110°

BOOM

Boom type	DB 130HD
Boom reach	4.5 m
Drilling coverage	12 m ²
Boom swing	+/- 45°
Collaring height	+2.3/-3.1
Horizontal holes	Sideways, forwards

POWERPACK

Engine type	CAT C 2.2 (Tier3)
Number of cylinders	4
Engine output	36,3 kW / 2800 rpm
Transmission type	Direct/polygroove belt
Screw compressor type	Enduro EN3
Air filters	2 pcs
Fuel tank	75 l

HYDRAULIC SYSTEM

Number of gear pumps	4 pcs
Filtration rate	10 micron abs.
Cooling capacity	up to +50°C ambient
Hydraulic oil tank	47 l
Shank lubrication device	WL 39

CONTROL SYSTEM

Control system type	Sandvik SICA, PLC controlled proportional electro- hydraulics
Tramming/boom/ drilling control	PLC controlled
User interface	Radio remote and touch screen
Control system diagnostics	Graphical flow chart diagnostic system
Drilling control system type	iTorque
Half percussion/minimum percussion	Standard
Antijamming system	Standard
Collaring control	Stepless
Auto-stop to preset hole depth	Option
Voltage	24 VDC

DUST COLLECTOR

Dust collector type	DC 130H
Capacity/vacuum	5 m ³ /min at 855 mm vacuum H ₂ O
Filter elements/material	6 pcs/fiber
Total filter surface	4.8 m ²

CARRIER

Ground clearance	300 mm
Tramming force	24 kN
Max. tramming speed	2.7 km/h

STANDARD COMPONENTS

Rock drill RD106, hydraulic
Chain feed CF 100 x 32, incl. one set of jaws
Rod rack on the carrier
Boom DB130 HD, articulated
Carrier, rubber-tyred
4 pcs Hydraulic jacks, front legs extendable
Power pack, diesel driven, hydraulic pumps and on-board compressor
Hydraulic system, electric load sensing
Control system, radio remote control
Hydraulic power take off
Dust collection system DC130H, hydraulic
6 pcs Working lights
1 Set Manuals, paper copy
1 Set Manuals, USB memory
EU-safety devices

THE JAWS FOR DRILL STEELS

DRILL STEEL TYPE	DRILL STEEL DIAMETER	RECOMMENDED HOLE DIAMETER
Steel	19 mm 3/4"	22 - 27 mm 7/8" - 1 1/16"
Steel	22 mm 7/8"	28 - 45 mm 1 7/64" - 1 3/4"
Steel	25 mm 1"	35 - 45 mm 1 3/8" - 1 3/4"
Steel	28 mm 1 1/8"	35 - 45 mm 1 3/8" - 1 3/4"

SELECTION OF OPTIONS

Spirit level angle indicator
TIMi for vertical holes and hole depth measuring
TIMi horizontal holes measurement (requires TIMi)
TIMi aligned holes with GPS and hole depth measurement
Auto alignment for DC TIMi
Kit for alternative steels, each
Pulling device for 22 mm (7/8") rods
Front centralizer Pito 1 *
Safety cage for feed, MANDATORY for EU, US, CAN and AUS
Feed motor upgrade OMR160
Feed-percussion follow up
Torque control
Hydraulic roll-over DC130
Biodegradable hydraulic oil
Central lubrication system Lincoln
Chain tracks
Power Trimming
Electric fuel filling pump
Hydraulic winch
Remote screen interface (Tablet or mobile phone not included)
Manual fuel filling pump
Led lights 6 pcs
Led side lights 2 pcs
Electric engine heater and float charger 230 V
Fuel powered heater for engine
Flushing control automatics
Shut down of suction for water holes
Raised dust collector
Water flushing kit without water pump
Grinder Dynaset
Grinder Sandvik RG100H
Grinder Sandvik RG400
Steel wearing strips for chain feed
Spare radio remote transmitter
Shoulder harness for radio remote transmitter
First service kit for DC130Ri
Tools for RD106, field kit (not include punches)
Punches for RD106, workshop kit
My Sandvik and SanRemo

COVERAGE AREA AND DIMENSIONS

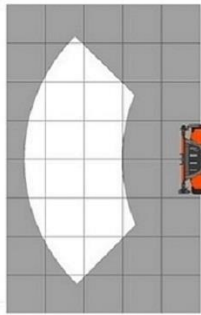

Vertical drilling

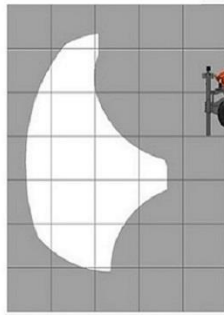

Vertical drilling

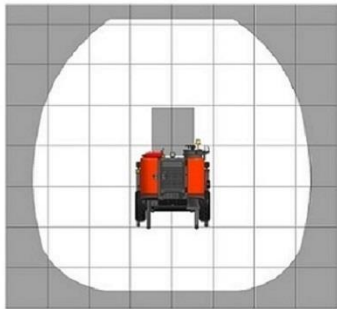

Face drilling with roll-over

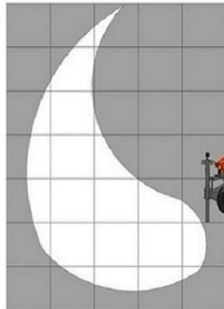

Horizontal drilling sideways

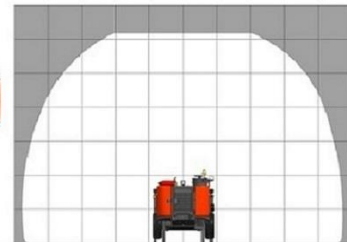

Bolting with roll-over



5140

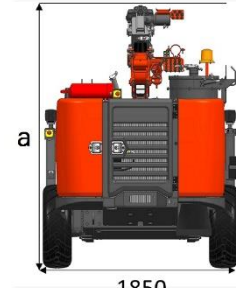

1850

DIMENSIONS

Weight	3250 kg
Width	1.85 m
Height	a, 2.49 m
With safety cage	a, 2.54 m
Total length	5.14 m

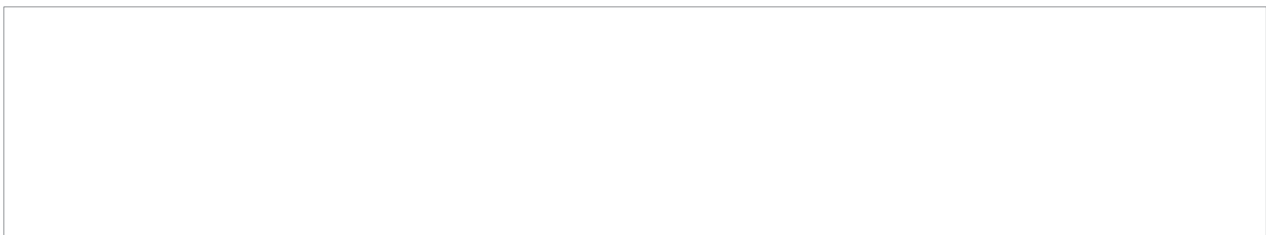

Sandvik Mining and Rock Solutions reserves the right to make changes to the information on this data sheet without prior notification to users. Please contact a Sandvik representative for clarification on specifications and options.

ROCKTECHNOLOGY.SANDVIK