

DRILL FASTER AND REDUCE YOUR COSTS

SANDVIK RH560 3.5", 4", 5" AND 6" DTH HAMMERS



HIGHER PRODUCTIVITY, REDUCED DOWNTIME

The all-new RH560 DTH hammer has been developed to be a robust and reliable addition to your surface mining and underground production drilling customers. It helps you drill faster and lower your drilling cost per hole.

The RH560 hammer is made for jobs that require a more efficient air cycle, allowing you to get more energy out of each blow of the piston and increase your rate of penetration. Using less air, you still get a high output of power that is more energy efficient and uses less fuel.

It also does not use a foot valve in the bits, which will help prevent inconvenient and costly breakdowns. Instead, designed so the airflow can be handled without the use of a foot valve. With less leakage, you'll enjoy better efficiency and lower energy costs.

Other improvements have made the RH560 an even more reliable and functional workhorse in your operations:

- Industry-standard shanks without the foot valve – a proven and reliable technology
- Robust piston, increased reliability
- A new bit retaining system, that are able to carry high loads to prevent bit failures
- A reduced number of inner components minimizes parts breakage
- A V-lock system prevents component movement
- Less air is required, allowing you to build pressure much faster and shorten start up phase for the drill

SANDVIK RH560 3.5"

COMPLETE HAMMER

2 3/8" API Reg Pin	32-5635-SRA-16S
#21 Cubex Pin	32-5635-SRA-63S

WEIGHT		OUTSIDE DIAMETER		HAMMER LENGTH		HAMMER LENGTH WITH BIT			
						Bit closed		Bit extended	
kg	lb	mm	inch	mm	inch	mm	inch	mm	inch
29	63.8	85	3.3	914	36.0	979	38.5	1,004	39.5

AIR CONSUMPTION, CFM			AIR CONSUMPTION, M3/MIN, DIN 1343		
150 psi	250 psi	350 psi	10 bar	18 bar	24 bar
159	293	392	4.5	8.3	11.1



REPLACEMENT PARTS ITEM DESCRIPTION	Weight, kg	Weight, lb	Part No.
1. Top Sub			
2 3/8" API Reg Pin	5.8	12.8	BG00014759
#21 Cubex Pin	5.8	12.8	BG00568016
2. Check Valve Dart no Choke	0.3	0.7	BG00904454
3. Check Valve Spring	0.02	0.04	BG00876172
4. Make Up Ring	0.1	0.2	BG00014763
5. Air Distributor with O-Ring	1.9	4.2	BG00100316
6. O-Ring Air Distributor			In seal kit
7. Inner Cylinder	1.9	4.2	BG00100315
8. Piston	5.3	11.7	BG00216128
9. Piston Case	10.2	22.4	BG00227151
10. Piston retaining ring			BG00014773
11. O-Ring Guide Sleeve			In seal kit
12. Guide Sleeve with O-Ring	1.3	2.9	BG00216219
13. Bit Retainer Ring	0.2	0.4	BG00227169
14. O-Ring Bit Retainer Ring			In seal kit
15. Driver Sub	1.9	4.2	BG00203662

Seal Kit			
1 Piece of 6, 14 & 2 of 11	0.01	0.02	BG01010257

Rebuild Kit			
1 piece of 1,9,15 & Seal Kit			
2 3/8" API Reg Pin	17.0	37.4	BG01010292
#21 Cubex Pin	17.0	37.4	BG01010301

Bit shank			
SS3.5			

SANDVIK RH560g 4"

COMPLETE HAMMER

2 3/8" API Reg Pin	32-5645-GTA-16S
#24 Cubex Pin	32-5645-GTA-77S

WEIGHT		OUTSIDE DIAMETER		HAMMER LENGTH		HAMMER LENGTH WITH BIT			
						Bit closed		Bit extended	
kg	lb	mm	inch	mm	inch	mm	inch	mm	inch
48	105.6	105	4.1	1,016	40	1,106	43.5	1,140	44.9

AIR CONSUMPTION, CFM			AIR CONSUMPTION, M3/MIN, DIN 1343			
150 psi	250 psi	350 psi	10 bar	18 bar	24 bar	
237	441	597	6.7	12.5	16.9	

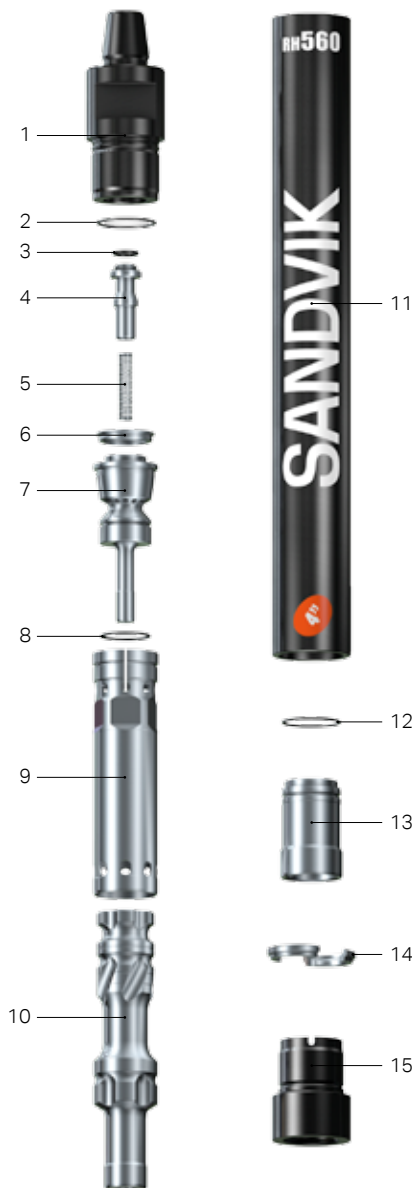

REPLACEMENT PARTS ITEM DESCRIPTION	Weight, kg	Weight, lb	Part No.
1. Top Sub			
2 3/8" API Reg Pin	9.4	20.7	BG00378463
#24 Cubex Pin	9.0	19.8	BG00906532
2. O-ring Top Sub			
In seal kit			
3. O-ring Check Valve Dart			
In seal kit			
4. Check Valve Dart no Choke	0.3	0.7	BG00904454
5. Check Valve Spring	0.04	0.1	BG00876172
6. Make Up Ring	0.1	0.2	BG00014825
7. Air Distributor with O-Ring	2.8	6.2	BG00377566
8. O-Ring Air Distributor			
In seal kit			
9. Inner Cylinder	2.6	5.7	BG00376970
10. Piston	8.5	18.7	BG00334820
11. Piston Case	19.5	42.9	BG00361296
12. O-Ring Guide Sleeve			
In seal kit			
13. Guide Sleeve with O-Ring	1.3	2.9	BG00334637
14. Bit Retainer Ring	0.2	0.4	BG00811287
15. Driver Sub	3.4	7.5	BG00803816

Seal Kit			
1 Piece of 2, 3, 8 & 12	0.01	0.02	BG00925938

Rebuild Kit			
1 piece of 1,11,16 & Seal Kit			
2 3/8" API Reg Pin	32.4	71.3	BG00933221
#24 Cubex Pin	32.0	70.4	BG00933225

Bit shank			
QLX560-4			



SANDVIK RH560g 5"

COMPLETE HAMMER

3 1/2" API Reg Pin	32-5655-GQA-04C
#24 Cubex Pin	32-5655-GQA-77C

WEIGHT		OUTSIDE DIAMETER		HAMMER LENGTH		HAMMER LENGTH WITH BIT			
kg	lb	mm	inch	mm	inch	Bit closed		Bit extended	
						mm	inch	mm	inch
76	167	127	5,0	1,052	41.4	1,141	41	1,170	42.1

AIR CONSUMPTION, CFM			AIR CONSUMPTION, M ³ /MIN, DIN 1343			
150 psi	250 psi	350 psi	10 bar	18 bar	24 bar	
250	526	755	7.1	14.9	21.4	

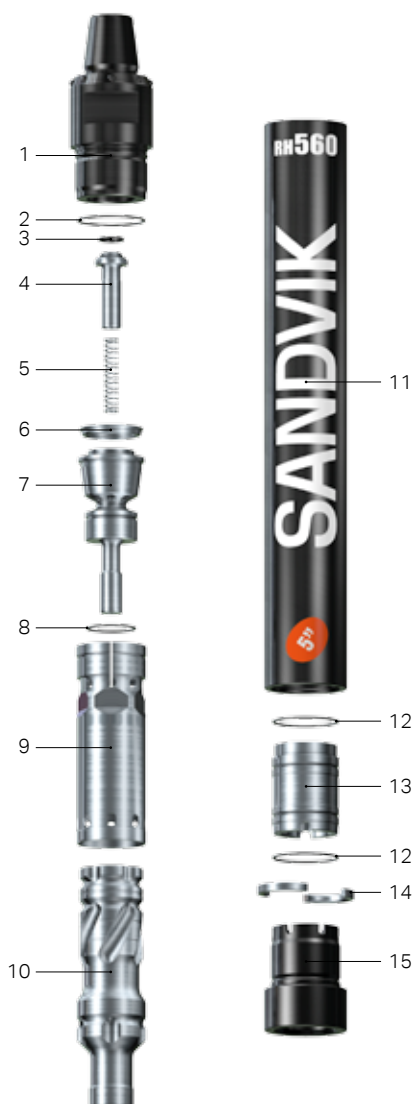

REPLACEMENT PARTS ITEM DESCRIPTION Weight, kg Weight, lb Part No.

1. Top Sub			
3 1/2" API Reg Pin	16.2	35.7	BG00419346
#24 Cubex Pin	15.2	33.5	BG01179147
2. O-ring Top Sub			
			In seal kit
3. O-ring Check Valve Dart			
			In seal kit
4. Check Valve Dart no Choke	0.5	1.1	BG00906719
5. Check Valve Spring	0.02	0.04	BG00854876
6. Make Up Ring	0.2	0.4	BG00014994
7. Air Distributor with O-Ring	4.6	10.1	BG00419578
8. O-Ring Air Distributor			In seal kit
9. Inner Cylinder	3.9	8.6	BG00419463
10. Piston	15.0	33.1	BG00418976
11. Piston Case	26.0	57.3	BG00418712
12. O-Ring Guide Sleeve			In seal kit
13. Guide Sleeve with O-Ring	3.2	7.1	BG00418725
14. Bit Retainer Ring	0.2	0.4	BG00817463
15. Driver Sub	5.6	12.3	BG00817456

Seal Kit

1 Piece of 2, 3, 8 & 2 of 12	0.01	0.02	BG01074634
------------------------------	------	------	------------

Rebuild Kit

1 piece of 1,11,15 & Seal Kit			
3 1/2" API Reg Pin	48	106	BG01178984
#24 Cubex Pin	47	104	BG01179148

Bit Shank

QL560-5



SANDVIK RH560g 6"

COMPLETE HAMMER

3 1/2" API Reg Pin	32-5665-GQA-04C
#28 Cubex Pin	32-5665-GQA-56C

WEIGHT		OUTSIDE DIAMETER		HAMMER LENGTH		HAMMER LENGTH WITH BIT			
						Bit closed		Bit extended	
kg	lb	mm	inch	mm	inch	mm	inch	mm	inch
117	257.9	150	5.9	1,158	45.6	1,266	49.8	1,307	51.5

AIR CONSUMPTION, CFM			AIR CONSUMPTION, M ³ /MIN, DIN 1343			
150 psi	250 psi	350 psi	10 bar	18 bar	24 bar	
310	629	847	8.8	17.8	24	



REPLACEMENT PARTS ITEM DESCRIPTION	Weight, kg	Weight, lb	Part No.
1. Top Sub			
3 1/2" API Reg Pin	25.4	56.0	BG00867633
#28 Cubex Pin	27	59.5	BG00859367
2. O-ring Top Sub			
In seal kit			
3. O-ring Check Valve Dart			
In seal kit			
4. Check Valve Dart no Choke	0.7	1.5	BG00904397
5. Check Valve Spring	0.03	0.07	BG00854872
6. Make Up Ring	0.4	0.9	BG00014865
7. Air Distributor with O-Ring	6.2	13.7	BG00386925
8. O-Ring Air Distributor			
In seal kit			
9. Inner Cylinder	5.8	12.8	BG00385028
10. Piston	23	50.7	BG00384750
11. Piston Case	43	94.8	BG00867630
12. O-Ring Guide Sleeve			
In seal kit			
13. Guide Sleeve with O-Ring	5	11.0	BG00695224
14. Bit Retainer Ring	0.4	0.9	BG00694800
15. Driver Sub	7.2	15.9	BG00867631

Seal Kit			
1 Piece of 2, 7 & 2 of 11	0.01	0.02	BG00874941





Rebuild Kit			
1 piece of 1,10,14 & Seal Kit			
3 1/2" API Reg Pin	75	165.3	BG00909795
#28 Cubex Pin	76	167.6	BG00909848

Bit Shank			
------------------	--	--	--







QL560-6







SANDVIK SS3.5 BITS

SANDVIK RH560	Diameter		Air holes	Gauge buttons	Button dia. mm		Weight		Part No.	Shank	
	mm	inch			gauge	front	kg	lb			
SS3.5 bits											
Concave face / Spherical button										SS3.5 Shank	
	100	3 7/8	2	8	13	12	6.7	14.7	42-3R13100-S48		
	105	4 1/8	2	8	13	12	7.0	15.4	42-3R13105-S48		
	115	4 1/2	2	8	14	13	7.4	16.3	42-3R1A115-S65		
Convex face / Ballistic button											
	95	3 3/4	2	8	12	12	6.4	14.1	42-3R51095-R48		
	100	3 7/8	2	8	13	12	6.6	14.5	42-3R53100-R48		
	105	4 1/8	2	8	13	13	6.8	15.0	42-3R54105-R48		
Flat Face / Ballistic button											
	105	4 1/8	2	8	13	13	7.0	15.4	42-3RF4105-R48		
Flat face / Spherical button											
	95	3 3/4	2	8	12	12	6.6	14.5	42-3RF1095-S48		
	100	3 7/8	2	8	13	12	6.8	15.0	42-3RF3100-S48		
	105	4 1/8	2	8	13	13	7.0	15.4	42-3RF4105-S48		
	105	4 1/8	2	8	13	13	7.0	15.4	42-3RF4105-S65		







SANDVIK QLX560-4 BITS

SANDVIK RH560	Diameter		Air holes	Gauge buttons	Button dia. mm		Weight		Part No.	Shank	
	mm	inch			gauge	front	kg	lb			
QLX560-4 bits											
Concave face / Spherical button										QLX 560-4 Shank	
	115	4 1/2	2	8	14	13	9.8	21.6	42-4H1A115-S48		
	115	4 1/2	2	8	14	13	9.8	21.6	42-4H1A115-S65		
	121	4 3/4	2	8	14	13	9.9	21.8	42-4H18121-S65		
	127	5	2	8	14	13	10.4	22.9	42-4H1A127-S48		
	127	5	2	8	14	14	10.3	22.7	42-4H1B127-S65		
Concave face / Ballistic button											
	115	4 1/2	2	8	14	13	8.6	18.9	42-4H1A115-R48		
	115	4 1/2	2	8	14	13	8.6	18.9	42-4H1A115-R55		
	127	5	2	8	14	13	10.3	22.7	42-4H1B127-R48		
Convex face / Ballistic button											
	115	4 1/2	2	8	14	13	9.5	20.9	42-4H5A115-R48		
Flat face / Spherical button											
	115	4 1/2	2	8	14	13	9.8	21.6	42-4HFA115-S48		
	115	4 1/2	2	8	16	13	9.7	21.3	42-4HF8115-S65		
	115	4 1/2	2	8	16	13	8.7	19.1	72-4Hw8115-S48		
	115	4 1/2	2	8	16	13	8.7	19.1	72-4Hw8115-S65		
	127	5	2	8	14	14	10.3	22.7	42-4HFB127-S48		
Uniface / Spherical button											
	121	4 3/4	3	9	16	13/11	9.9	21.8	42-4HYY121-S55		

SANDVIK QL560-5 BITS

SANDVIK RH560	Diameter		Air holes	Gauge buttons	Button dia. mm		Weight		Part No.	Shank
	mm	inch			gauge	front	kg	lb		
QL560-5 bits										
Concave face / Spherical button										
	140	5 1/2	2	8	16	14	16.2	35.6	42-5H19140-S48	
	140	5 1/2	2	8	16	14	16.2	35.6	42-5H19140-S65	
	146	5 3/4	2	8	16	14	16.6	36.5	42-5H19146-S48	
	152	6	2	8	18	16	16.8	37.0	42-5H1D152-S48	
	165	6 1/2	2	8	18	16	17.9	39.4	42-5H1D165-S48	
Concave face / Ballistic button										
	140	5 1/2	2	8	16	14	16.3	35.9	42-5H19140-R55	
Convex face / Ballistic button										
	140	5 1/2	3	9	16	16	16.1	35.4	42-5HLC140-R55	
	146	5 3/4	3	9	16	16	16.7	36.7	42-5HLC146-R48	
	146	5 3/4	3	9	16	16	16.7	36.7	42-5HLC146-R55	
Flat face / Spherical button										
	140	5 1/2	3	9	16	14	16.5	36.3	42-5H29140-S48	
	152	6	3	9	18	16	17.2	37.8	42-5H2D152-S48	

SANDVIK QL560-6 BITS

SANDVIK RH560	Diameter		Air holes	Gauge buttons	Button dia. mm		Weight		Part No.	Shank
	mm	inch			gauge	front	kg	lb		
QL560-6 bits										
Concave face / Spherical button										
	165	6 1/2	3	9	18	18	24.1	53.0	42-63DE165-S48	
	165	6 1/2	3	9	18	18	24.1	53.0	42-63DE165-S65	
	172	6 3/4	3	9	18	18	24.8	54.6	42-63DE172-S48	
	172	6 3/4	3	9	18	18	24.8	54.6	42-63DE172-S65	
Convex face / Ballistic button										
	165	6 1/2	3	9	18	18	24.2	53.2	42-63GE165-R55	
	172	6 3/4	3	9	18	18	24.6	54.1	42-63GE172-R55	
Convex face / Spherical button										
	172	6 3/4	3	9	18	18	25.8	56.8	42-63GE172-W55	
	190	7 1/2	3	9	18	18	28.8	63.4	42-63GE190-W55	
Flat face / Spherical button										
	165	6 1/2	3	9	18	18	25.2	55.4	42-632E165-S48	
	172	6 3/4	3	9	18	18	26.0	57.2	42-632E172-S48	
	203	8	3	9	18	18	31.4	69.1	42-632E203-S48	
Uniface / Spherical button										
	165	6 1/2	4	8	18	18/16/14/13	24.0	52.8	42-63YY165-S48	
	165	6 1/2	4	8	18	18/16/14/13	24.0	52.8	42-63YY165-S65	
	172	6 3/4	4	8	18	18/16/14/13	24.8	54.6	42-63YY172-S48	
	172	6 3/4	4	8	18	18/16/14/13	24.8	54.6	42-63YY172-S65	

Sandvik Mining and Rock Technology reserves the right to make changes to the information on this data sheet without prior notification to users. Please contact a Sandvik representative for clarification on specifications and options.

